



الجابر للرافعات الثقيلة والنقلات ذ.م.م
**Al Jaber Heavy Lift
 & Transport LLC**

CONTACT DETAILS:-

UNITED ARAB EMIRATES (U.A.E).

E-mail: ajhl@eim.ae

QATAR.

Email: ajhl@ajhl.com.qa

SINGAPORE.

Email: ajhl@ajhl.com.sg

WEBSITE :-

www.ajhl.com

01/09



الجابر للرافعات الثقيلة والنقلات ذ.م.م
**Al Jaber Heavy Lift
 & Transport LLC**

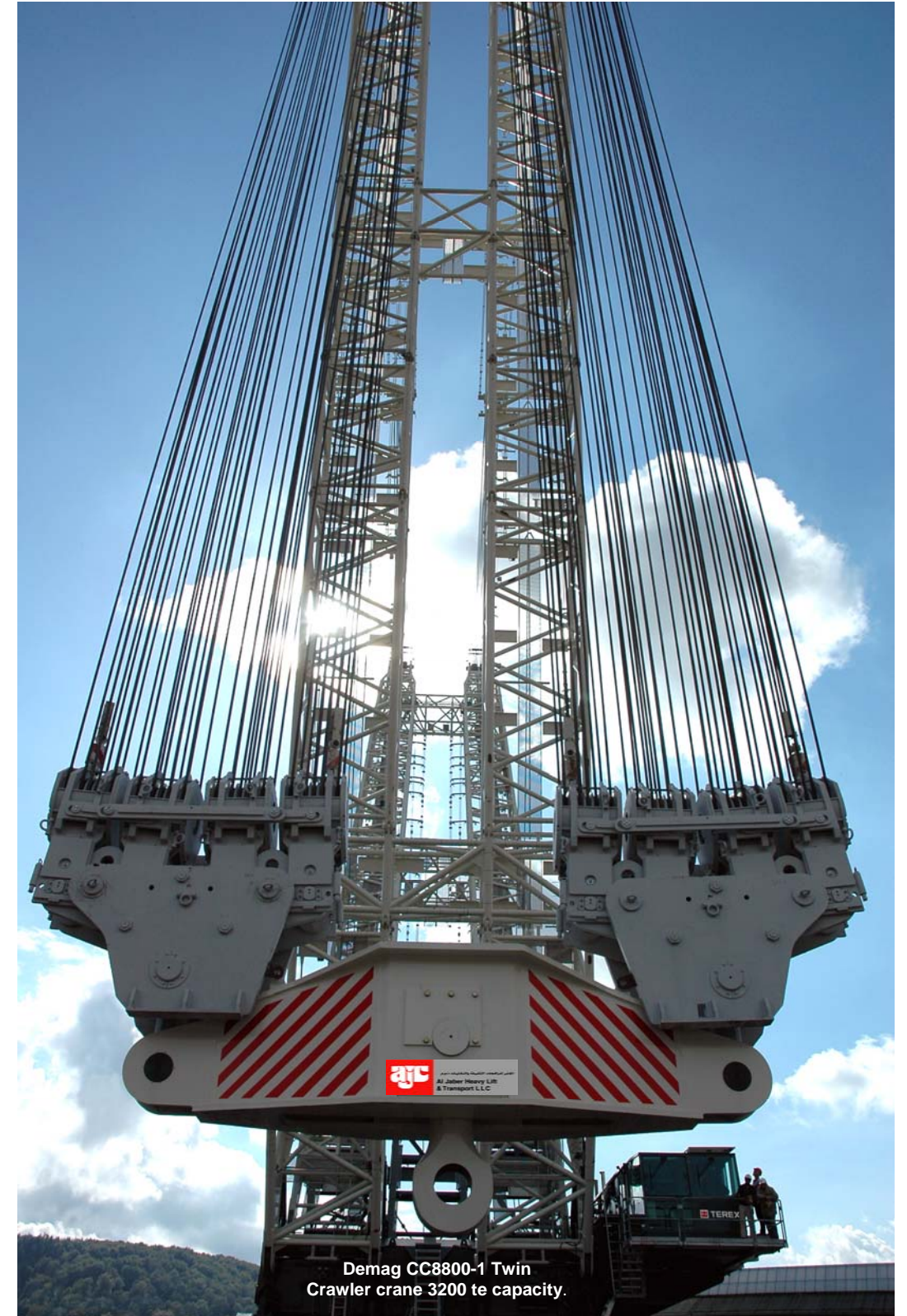

Demag CC8800-1 Twin
 Crawler crane 3200 te capacity.

Mission Statement:-

To consistently provide our clients with safe, comprehensive, high quality heavy lifting and transportation services which meet world class standards.

Health, Safety & Environment:-

Health, safety and environmental concerns are our first priority. Therefore, we have developed our procedures and documentation to the highest international standards and we ensure that they are comprehensively applied to our projects.

Our health, safety & environmental policy provides that it is a primary and continuing priority in the conduct of our activities that we endeavour to protect the health and safety of everyone affected by these activities and we endeavour to limit the adverse effects on the physical environment in which our activities are carried out.

Therefore, in our efforts to set safety and environmental standards we:

- Provide and maintain a safe, healthy working environment in compliance with all local regulations and legislation, together with all appropriate international standards and regulations.
- Ensure that all items of plant, equipment and all substances used in our diverse operations are properly used, maintained and handled in a manner so as not to constitute a risk to persons or the environment.
- Ensure that all employees are informed of the operational and safety standards, practices, objectives and procedures and that we train them in the attitudes, skills and knowledge in order to achieve these requirements.
- Ensure that all employees are made aware of their own responsibilities towards themselves and others. We encourage them to adopt safe, healthy working practices at all times during the course of their employment.
- Establish feed back procedures and systems and encourage all personnel to participate in matters of health and safety.
- Carry out regular audits, inspections and surveys of all its sites and activities to ensure the compliance with and adherence to these standards and conditions.
- Make assessments of all prospective activities, new works, developments, acquisitions or modifications to ensure their compliance with these standards and requirements.

Training:-

Training is integral to the development of our safe, efficient and multi-skilled workforces and an essential element of our work philosophy. Our personnel are all trained and externally certified to appropriate levels which comply with international standards. This ensures that our teams are capable of handling expensive and delicate equipment and that they are fully aware of the consequences and impact on project schedules if not handled correctly.



Cranes up to 3200 te capacity.



Modular Trailers with capacities upto 40 te per axle line.



Marine operations.

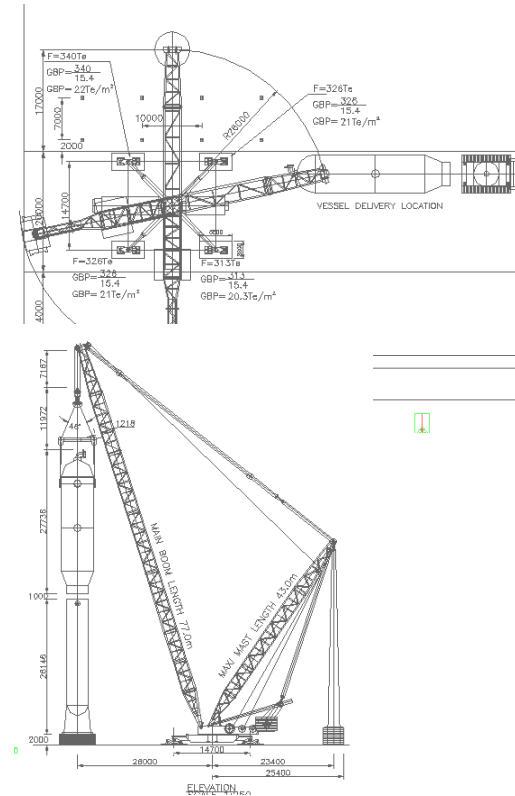

Erecting a 360 te demethanizer in Iran at 30m above ground level in Iran.



Weighing a 4015 te of rig hull "Thule Power" by means of 154 SPMT Hydraulic axle Lines and marine load out onto barge in the U.A.E

Our objective is to consistently provide our clients with safe, comprehensive, high quality heavy lifting and transportation services which meet world class standards. Therefore, we place great emphasis on understanding and supporting our clients through personal contact and assistance in the planning of our services to achieve the best possible solution and the most cost effective, safe handling of their goods. We believe that the successful implementation of our high professional standards largely depends upon our ability to anticipate even the smallest details in the operations.



Load out a 1700 te MED Unit in the U.A.E



Transporting a 270 te cryogenic exchanger using 24lines SPMT in Oman.

Quality Policy:-

Al Jaber Heavy Lift and Transport LLC is committed to providing professional contract heavy lifting, crane hire, heavy transporting and alternative lifting services to it's customers which meet world class standards. This is achieved through owning a well maintained fleet of cranes, vehicles and associated equipment, supported by a team of highly qualified, experienced and motivated staff whose expertise guarantees the quality of the services.

The company has an integrated quality system designed around the requirements of ISO 9001:2000 that ensures the needs and expectations of the customers are met. Within this system, Computer Aided Design is utilised to develop optimum equipment configurations and locations to safely meet the requirements of each contract on a timely basis.

Management and staff are committed to comply with and continually improve the effectiveness of the quality management system within the integrated framework for establishing and reviewing quality objectives.

Communication, both within the Company and with Customers, is vital for the delivery of any efficient service. This is given the highest priority by the management who train and develop the staff to international standards.

By concentrating on supplying a service of the highest quality Al Jaber Heavy Lift and Transport LLC has become an international leader in the provision of lifting and transportation services to the Petrochemical, Civil Engineering and Marine Industries. We intend to continually develop our service by responding to customer needs and proactively seeking ways to improve our quality system. We believe we are the best, but intend to become better.

Engineering:-

We believe engineering lies at the very heart of our business. When moving and erecting large and / or heavy objects there are numerous engineering constraints to overcome before determining the optimum solution. These are assessed by in depth engineering studies. Al Jaber Heavy Lift and Transport LLC provides all the necessary skills and expertise to engineer comprehensive packages which form the blueprints for the operations and contain all the necessary information to ensure that the work is conducted to the highest possible safety and quality standards. This evaluation process can be provided either as a separate consultancy service or as an integral part of our overall project execution services.



Our surveying team performs checks on foundation holding bolts and vessel orientation prior to lowering onto foundation.



Our site supervision executes quality checks of lashing and stability prior to transportation of the load

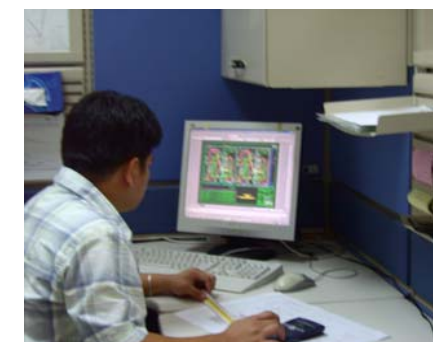

Computer aided design (CAD) and procedures are used by our Engineers.

1. Marine transportation



Al Jaber Heavy Lift and Transport LLC, a member of the Al Jaber Group, specializes in the full range of lifting and transportation services from hire and trip basis to the execution of totally engineered and managed “factory to foundation” projects comprising marine transportation, overland transportation and erection of cargo at site.

2. Overland transportation

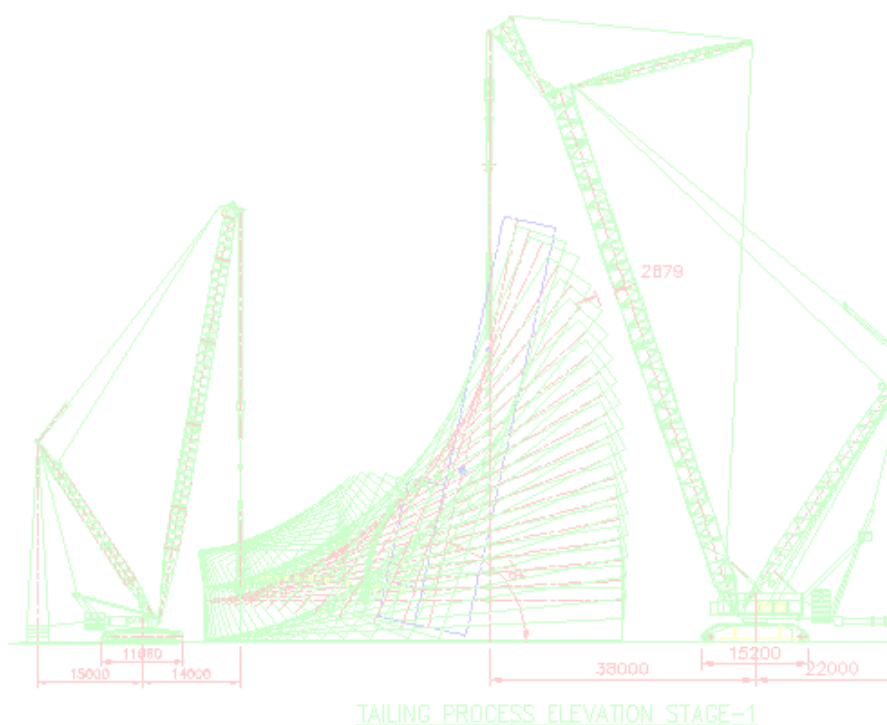

ILLUSTRATION PICTURES 1, 2 & 3

Location : UK to Qatar
 Equipment deployed : Demag CC8800 (1250 te crawler crane), Demag CC2800 (600 te crawler crane), 40 lines SPMT and heavy lift ship.

Collecting two cold boxes weighing 581 te (length 60m, width 7m, height 14m) from Ellesmere Port (UK), shipping to Ras Laffan Port (Qatar), overland transport to site using 40 lines SPMTs and erection onto the foundation using Demag CC8800 as main crane and Demag CC2800 as tailing crane.

3. Erection of cargo



Erecting a 500 te column using a Demag CC 8800-1

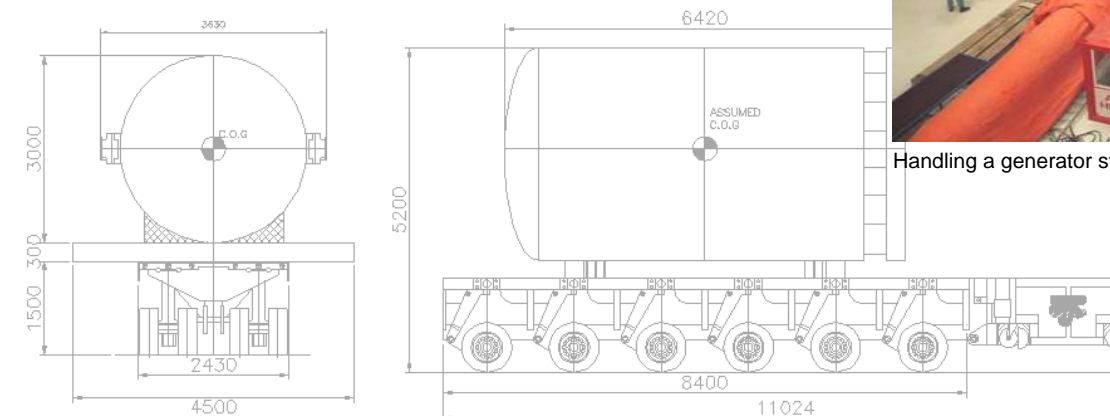
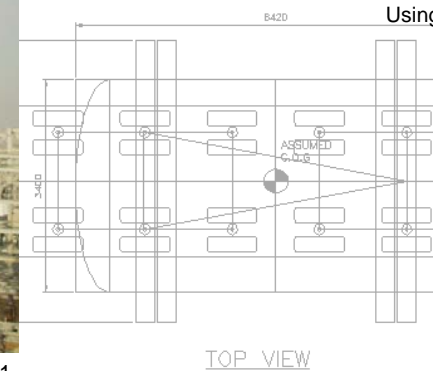

Handling a generator stator



Erecting 400 te reactor into a 17m high structure Using a Gottwald AK 912 in U.A.E



Load out a 550 te module at Al Jaber Mussafah jetty.

Al Jaber Heavy Lift and Transport LLC owns and operates an extensive fleet of latest generation cranes, self-propelled modular transporters and conventional trailers, including all necessary ancillary equipment to carry out our customers foreseeable heavy lift and transport requirements. In addition, the Al Jaber Group owns and operates a fleet of ships including barges and ro-ro vessels from in-house port facilities and can make available jetty space to clients for delivery and collection of heavy cargo.



Al Jaber marine jetty facility

1. Marine transportation



ILLUSTRATION PICTURES 1, 2 & 3

Location : UAE to Kargh Island (Iran)
 Equipment deployed : Demag AC 650 (650 te telescopic crane), 2 x 5 axle lines conventional trailers and self propelled landing craft.

Collecting a vessel weighing 147 te (length 34m, diameter 5m); shipping from UAE to Kargh Island by self propelled landing craft, land transportation and installation onto foundation using Demag AC 650.

3. Erection of cargo



2. Overland transportation



The operations are executed by our teams of highly experienced and motivated personnel whose technical expertise ensures the quality of our services. Emphasis is placed upon the implementation of homogenous and comprehensive documentation and procedures to ensure that our safety, engineering, quality and training requirements are implemented and maintained at the highest standards.

1. Marine transportation



2. Overland transportation



3. Erection of cargo

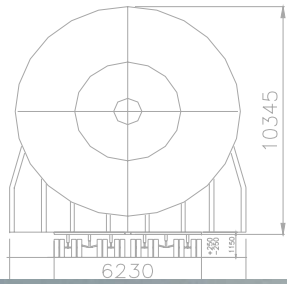

ILLUSTRATION PICTURES 1, 2 & 3

Location : Sharjah to Ruwais, (UAE)
 Equipment deployed : Demag CC8800-1 (1600 te crawler crane), Demag CC2800 (600te crawler crane), 48 lines SPMT, Al Jaber 30 (4500 DWT barge), Al Jaber 17 landing craft (2200 DWT), Al Jaber 6 (45 te bollard pull tag)

Marine loadout, transportation and discharge of three super heavy columns weighing upto 1,100 te (diameter 9.0m, length 64m) at the fabrication yard. Overland transportation to site using 48 lines SPMT's. Erection onto the foundations using Demag CC8800-1 as main crane and Demag CC2800 as tailing crane.

For more than 30 years we have carried out prestigious projects internationally involving the marine transportation, overland transportation and lifting of heavy equipment for industrial projects including petrochemical, gas, fertilizer plants, refineries, power & desalination plants.



1985- Erecting a 833 te reactor in Kuwait.



1986- Erecting a 210 te vessel in Iran.



1988- Erecting a 225 te reactor head in Holland.



1992- Erecting a 200 te vessel in the K.S.A.



1984-Transporting a 370 te reactor in the U.A.E

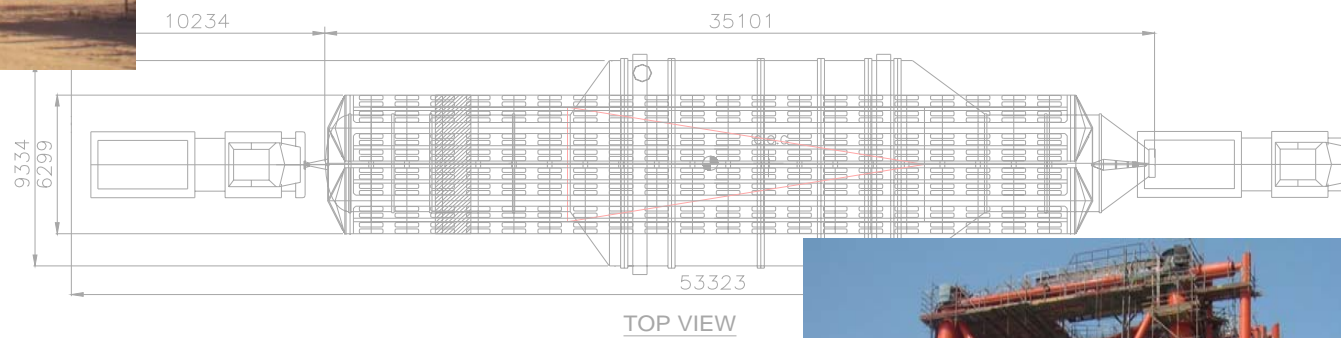
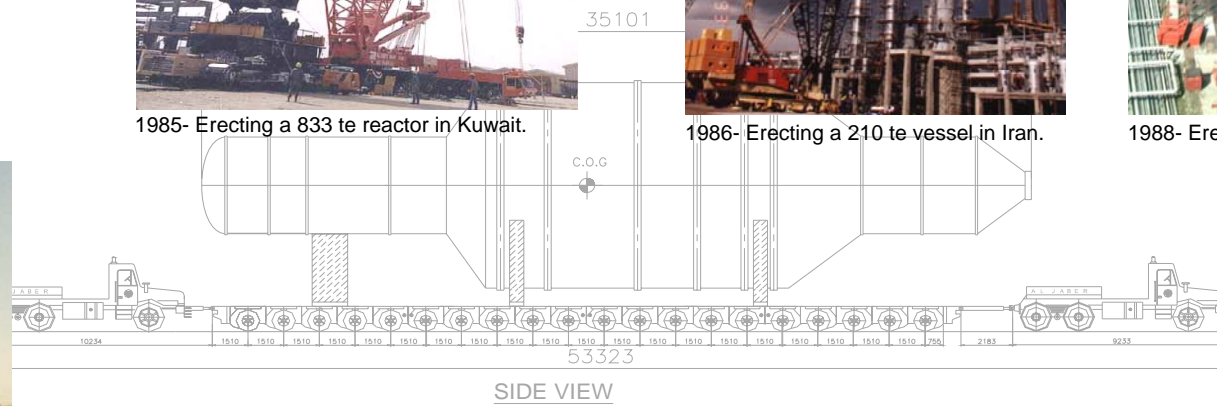

1985- Transporting & load out a 210 te offshore module in the U.A.E



2004- Erecting a 260 te compressor in Qatar.



2006- Receiving a 700 te vessel in the U.A.E

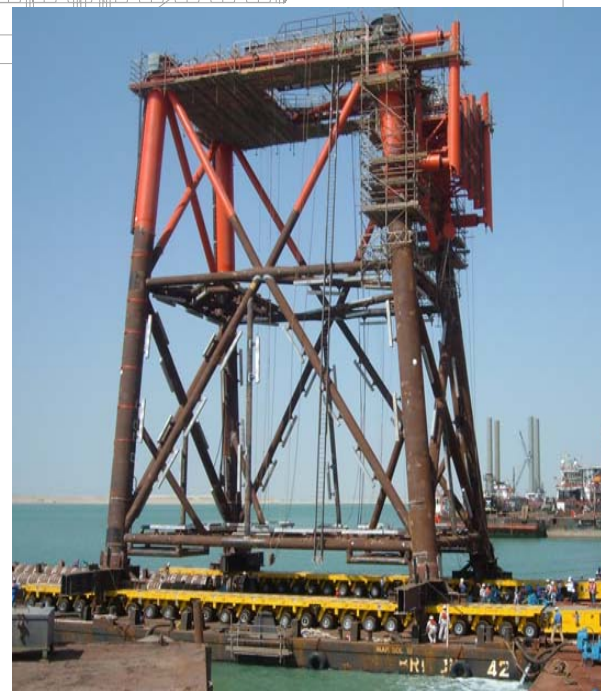

2006- Load out a 660 te STD jacket in the U.A.E



2007- 1200 te capacity crane mounted on the Global Process System Sdn Bhd jack up barge in Malaysia.